

# Bollard Post, Model R-7902

Removable Receiver with Lid  
*(for detail, see sheet 2 of 8)*

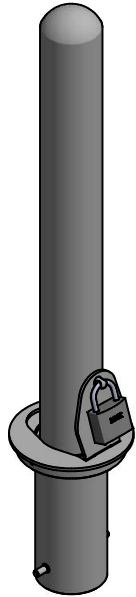

Removable Receiver with Chain  
*(for detail, see sheet 3 of 8)*

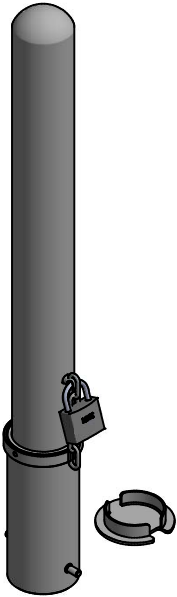

Fixed Embedded Mount  
*(for detail, see sheet 4 of 8)*



Flanged Surface Mount  
*(for detail, see sheet 5 of 8)*

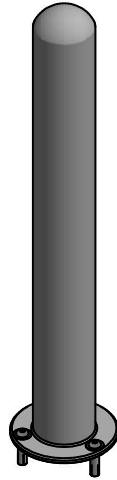

Fold Down Mount  
*(for detail, see sheet 6 of 8)*

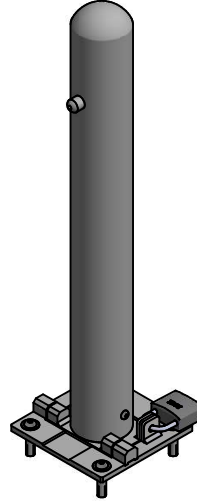

Removable Shallow Mount  
*(for detail, see sheet 7 of 8)*

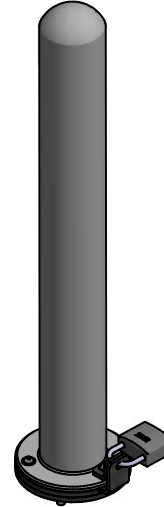

## 7 Available Mounting Options

5/16" Chain Accessories Installation Sample  
*(for detail, see sheet 7 of 7)*

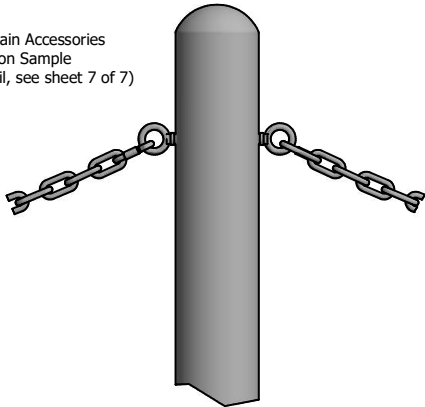

## Optional Chain Accessories Available



Chain Eye 3/8"  
(Powder Coated)



Quick Link Connector  
(Powder Coated)



Bollard Chain 5/16"  
(Powder Coated)

## General Description:

Make a pronounced statement on entry to your streetscape, business, park, school or stadium with the contemporary and practical design of the model R-7902 steel bollard. A staple of the product line, it will complement the aesthetics of almost any architectural style. It can be embedded in new concrete or surface-mounted on existing concrete. For locations where access needs fluctuate, it can also be installed with removable or fold down mountings. The model R-7902 can be finished in one of seven different powder-coated color options and it is kept in stock, available to ship immediately.

For more information on bollard post installation, please visit:  
[www.reliance-foundry.com/bollard/installation-bollards](http://www.reliance-foundry.com/bollard/installation-bollards)

## Specifications:

Height: 36" ( Above Grade )

Base Diameter: 4 3/8"

Weight: 31 lbs ( Bollard Post Full Length )

Material: Steel ( ASTM A36 )

### Finish Options:

- ✓ Polyester Powdercoated
- See Reliance Foundry's standard color options at [www.reliance-foundry.com/bollard/colors-bollards](http://www.reliance-foundry.com/bollard/colors-bollards)

## Mount Options:

- Removable Receiver with Lid  
(see sheet 2 of 8)
- Removable Receiver with Chain  
(see sheet 3 of 8)
- Fixed Embedded Mount  
(see sheet 4 of 8)
- Flanged Surface Mount  
(see sheet 5 of 8)
- Fold Down Mount  
(see sheet 6 of 8)
- Removable Shallow Mount  
(see sheet 7 of 8)
- Optional Chain Accessory  
(see sheet 8 of 8)

**RELIANCE FOUNDRY**  
SINCE 1925

Unit 207, 6450 - 148 Street, Surrey, BC V3S 7G7, Canada  
1-888-735-5680 info@reliance-foundry.com  
[www.reliance-foundry.com](http://www.reliance-foundry.com)

TITLE

**Bollard Post, Model R-7902**

SIZE  
C

DWG NO  
R-7902

REV  
C2

NOT TO SCALE

SHEET 1 OF 8

# Bollard Post, Model R-7902

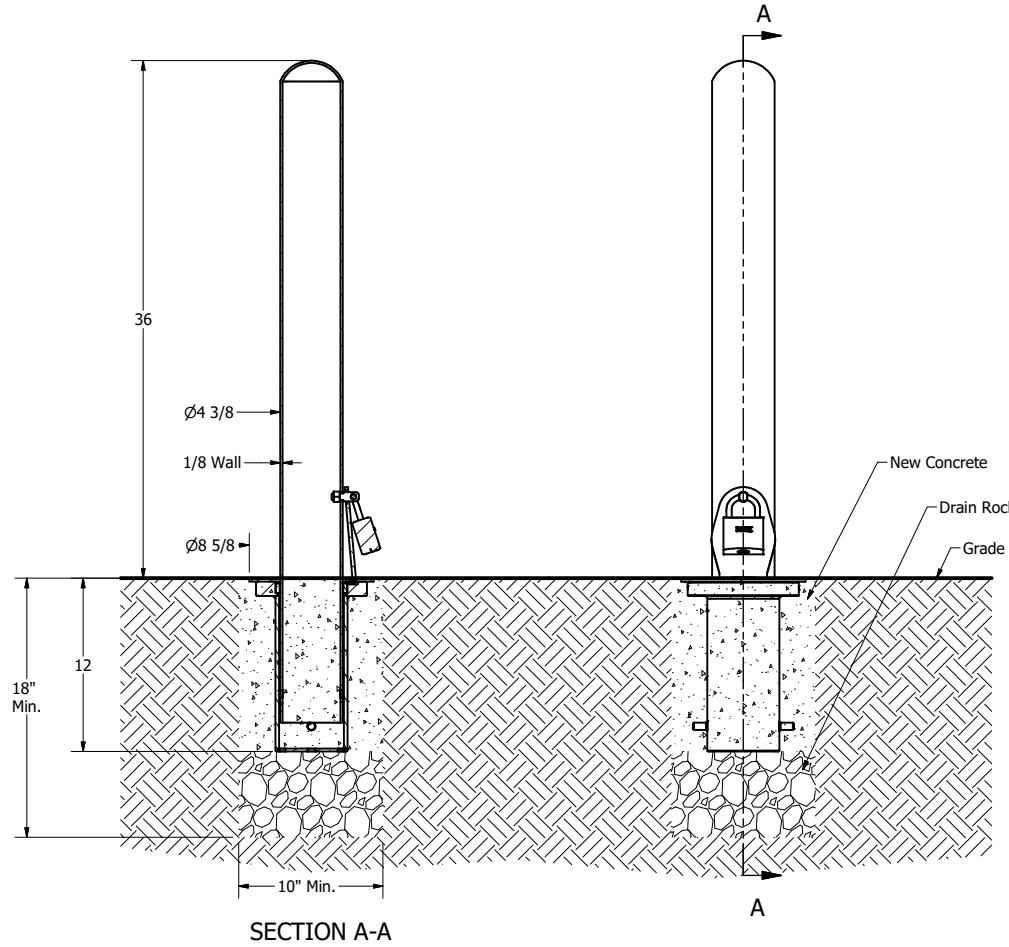

\* If local frost line exceeds 12" deep, provide adequate drainage by piping through concrete, connect to drain rock layer underneath

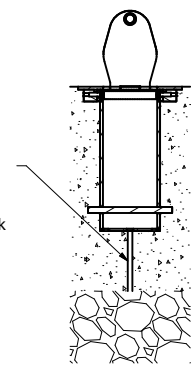
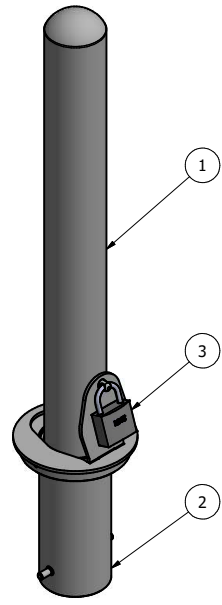

## General Description:

Make a pronounced statement on entry to your streetscape, business, park, school or stadium with the contemporary and practical design of the model R-7902 steel bollard. A staple of the product line, it will complement the aesthetics of almost any architectural style. It can be embedded in new concrete or surface-mounted on existing concrete. For locations where access needs fluctuate, it can also be installed with removable or fold down mountings. The model R-7902 can be finished in one of seven different powder-coated color options and it is kept in stock, available to ship immediately.

For more information on bollard post installation, please visit: [www.reliance-foundry.com/bollard/installation-bollards](http://www.reliance-foundry.com/bollard/installation-bollards)

## Specifications:

- Height: 36" ( Above Grade )
- Base Diameter: 4 3/8"
- Weight: 31 lbs ( Bollard Post Full Length )
- Material: Steel ( ASTM A36 )

## Finish Options:

- ✓ Polyester Powdercoated
- See Reliance Foundry's standard color options at [www.reliance-foundry.com/bollard/colors-bollards](http://www.reliance-foundry.com/bollard/colors-bollards)

## Mount Options:

- ✓ Removable Receiver with Lid (see sheet 2 of 8)
- Removable Receiver with Chain (see sheet 3 of 8)
- Fixed Embedded Mount (see sheet 4 of 8)
- Flanged Surface Mount (see sheet 5 of 8)
- Fold Down Mount (see sheet 6 of 8)
- Removable Shallow Mount (see sheet 7 of 8)
- Optional Chain Accessory (see sheet 8 of 8)

## Removable Receiver with Lid

(For important detail regarding installation with OPTIONAL bollard chain accessories, refer to sheet 7 of 7)

## Notes:

- Embedment details are for reference illustration only. Minimum foundation sizes depend on local soil conditions, weather conditions, and engineering requirements.
- Bollard post is provided as shown, with material detailed in legend below. Concrete, foundation and/or installation ordered separately or provided by others.
- This drawing is not drawn to scale. Dimensions provided herein is for reference only. Please consult Reliance Foundry sales professionals if any dimension is critical to your particular installation.
- Reliance Foundry reserves the right to amend design and specifications without prior notice for product improvement.

PARTS LIST					
ITEM	QTY	PART NUMBER	DESCRIPTION	MATERIAL	WEIGHT
1	1	R7902 Removable	Bollard R7902 Removable Assembly	Steel Powder Coated	31 lbs
2	1	R7901R Receiver	R7901R Receiver Assembly w/ Lid	Galvanized Steel w/ 316 Stainless Steel Cover	24 lbs
3	1	Padlock (Optional)	Optional Padlock (Brass or Stainless Steel)	Choice of Brass or Stainless Steel	5/8 lbs



Unit 207, 6450 - 148 Street, Surrey, BC V3S 7G7, Canada  
1-888-735-5680 info@reliance-foundry.com  
[www.reliance-foundry.com](http://www.reliance-foundry.com)

## Bollard Post, Model R-7902

SIZE	DWG NO	REV
C	R-7902	C2

# Bollard Post, Model R-7902

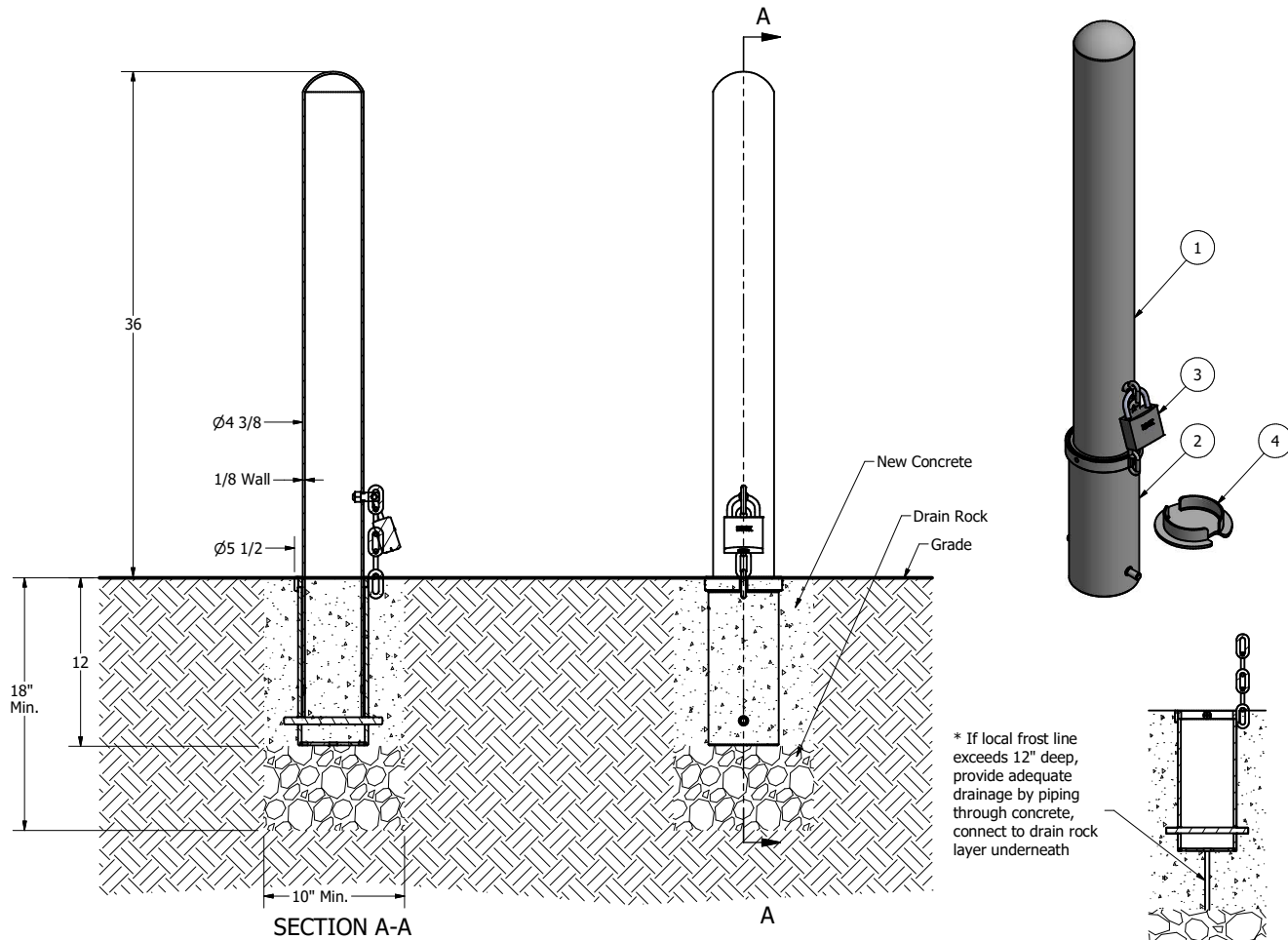

## Removable Receiver with Chain

(For important detail regarding installation with OPTIONAL bollard chain accessories, refer to sheet 7 of 7)

### Notes:

- Embedment details are for reference illustration only. Minimum foundation sizes depend on local soil conditions, weather conditions, and engineering requirements.
- Bollard post is provided as shown, with material detailed in legend below. Concrete, foundation and/or installation ordered separately or provided by others.
- This drawing is not drawn to scale. Dimensions provided herein is for reference only. Please consult Reliance Foundry sales professionals if any dimension is critical to your particular installation.
- Reliance Foundry reserves the right to amend design and specifications without prior notice for product improvement.

### General Description:

Make a pronounced statement on entry to your streetscape, business, park, school or stadium with the contemporary and practical design of the model R-7902 steel bollard. A staple of the product line, it will complement the aesthetics of almost any architectural style. It can be embedded in new concrete or surface-mounted on existing concrete. For locations where access needs fluctuate, it can also be installed with removable or fold down mountings. The model R-7902 can be finished in one of seven different powder-coated color options and it is kept in stock, available to ship immediately.

For more information on bollard post installation, please visit: [www.reliance-foundry.com/bollard/installation-bollards](http://www.reliance-foundry.com/bollard/installation-bollards)

### Specifications:

- Height: 36" ( Above Grade )
- Base Diameter: 4 3/8"
- Weight: 31 lbs ( Bollard Post Full Length )
- Material: Steel ( ASTM A36 )

### Finish Options:

- ✓ Polyester Powdercoated
- See Reliance Foundry's standard color options at [www.reliance-foundry.com/bollard/colors-bollards](http://www.reliance-foundry.com/bollard/colors-bollards)

### Mount Options:

- Removable Receiver with Lid (see sheet 2 of 8)
- ✓  Removable Receiver with Chain (see sheet 3 of 8)
- Fixed Embedded Mount (see sheet 4 of 8)
- Flanged Surface Mount (see sheet 5 of 8)
- Fold Down Mount (see sheet 6 of 8)
- Removable Shallow Mount (see sheet 7 of 8)
- Optional Chain Accessory (see sheet 7 of 8)

**RELIANCE FOUNDRY**  
SINCE 1925

Unit 207, 6450 - 148 Street, Surrey, BC V3S 7G7, Canada  
1-888-735-5680 info@reliance-foundry.com  
[www.reliance-foundry.com](http://www.reliance-foundry.com)

PARTS LIST					
ITEM	QTY	PART NUMBER	DESCRIPTION	MATERIAL	WEIGHT
1	1	R7902 Removable	Bollard R7902 Removable Assembly	Steel Powder Coated	31 lbs
2	1	R7902R Receiver	R7902R Receiver Assembly	Galvanized Steel, w/ 304 Stainless Steel Chain	16 lbs
3	1	Padlock (Optional)	Optional Padlock (Brass or Stainless Steel)	Choice of Brass or Stainless Steel	5/8 lbs
4	1	R7902RC Receiver Cover (Optional)	Optional R7902RC Receiver Cover	304 Stainless Steel	2 lbs

TITLE: **Bollard Post, Model R-7902**

SIZE: C DWG NO: R-7902 REV: C2

NOT TO SCALE SHEET 3 OF 8

# Bollard Post, Model R-7902

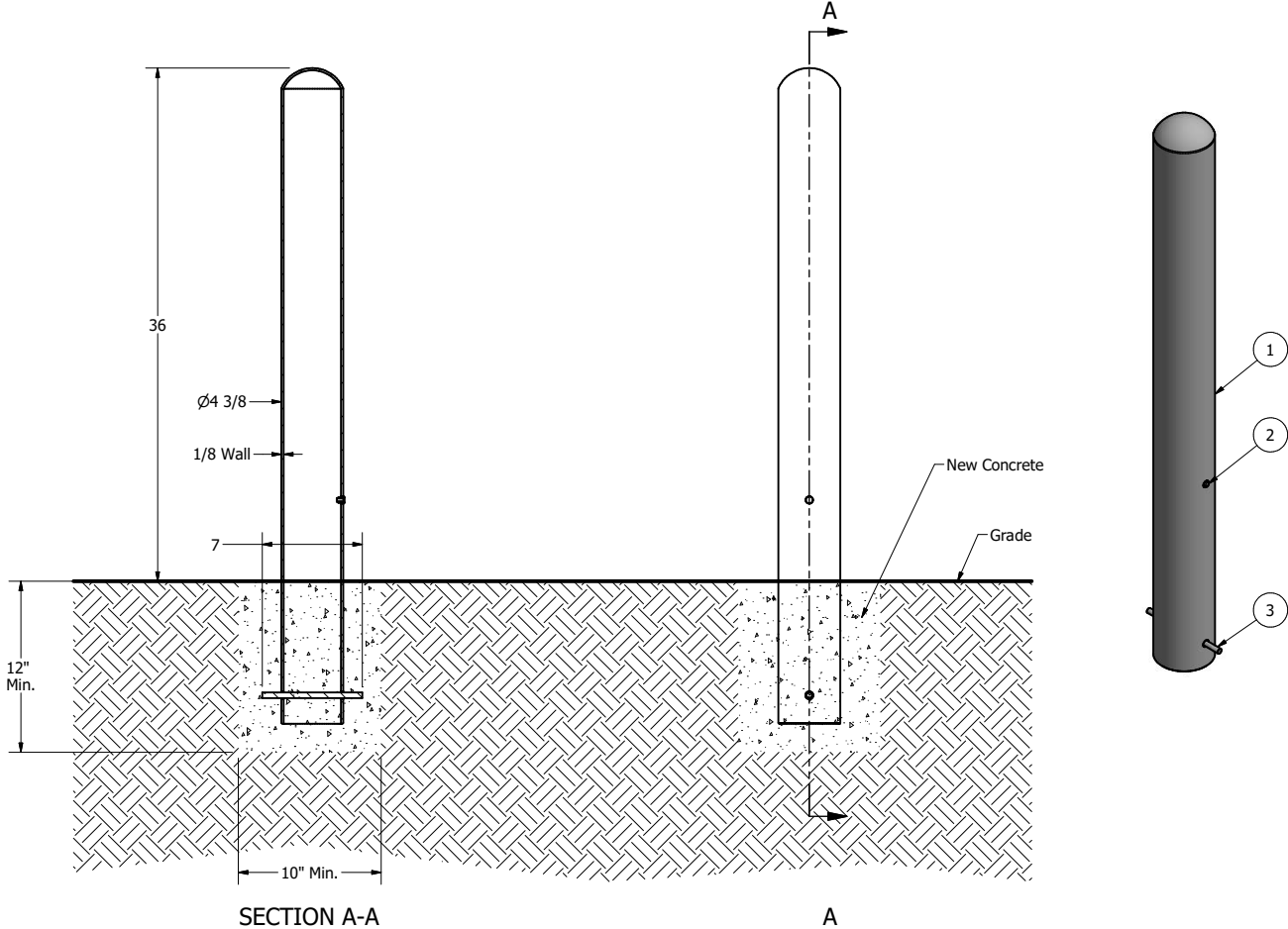

SECTION A-A

A

## Fixed Installation in New Concrete

### Notes:

- Embedment details are for reference illustration only. Minimum foundation sizes depend on local soil conditions, weather conditions, and engineering requirements.
- Bollard post is provided as shown, with material detailed in legend below. Concrete, foundation and/or installation ordered separately or provided by others.
- This drawing is not drawn to scale. Dimensions provided herein is for reference only. Please consult Reliance Foundry sales professionals if any dimension is critical to your particular installation.
- Reliance Foundry reserves the right to amend design and specifications without prior notice for product improvement.

PARTS LIST					
ITEM	QTY	PART NUMBER	DESCRIPTION	MATERIAL	WEIGHT
1	1	R7902 Fixed Bollard	R7902 Fixed Bollard Body	Steel Powder Coated	31 lbs
2	1	Polyethylene Plug 1/2"	Polyethylene Plug 1/2"	Polyethylene Plastic	
3	1	Steel Rebar	Steel Rebar 10 mm x 7"	Steel Epoxy Coated	3/8 lbs

### General Description:

Make a pronounced statement on entry to your streetscape, business, park, school or stadium with the contemporary and practical design of the model R-7902 steel bollard. A staple of the product line, it will complement the aesthetics of almost any architectural style. It can be embedded in new concrete or surface-mounted on existing concrete. For locations where access needs fluctuate, it can also be installed with removable or fold down mountings. The model R-7902 can be finished in one of seven different powder-coated color options and it is kept in stock, available to ship immediately.

For more information on bollard post installation, please visit: [www.reliance-foundry.com/bollard/installation-bollards](http://www.reliance-foundry.com/bollard/installation-bollards)

### Specifications:

- Height: 36" ( Above Grade )
- Base Diameter: 4 3/8"
- Weight: 31 lbs ( Bollard Post Full Length )
- Material: Steel ( ASTM A36 )

### Finish Options:

- ✓ Polyester Powdercoated
- See Reliance Foundry's standard color options at [www.reliance-foundry.com/bollard/colors-bollards](http://www.reliance-foundry.com/bollard/colors-bollards)

### Mount Options:

- Removable Receiver with Lid (see sheet 2 of 8)
- Removable Receiver with Chain (see sheet 3 of 8)
- ✓  Fixed Embedded Mount (see sheet 4 of 8)
- Flanged Surface Mount (see sheet 5 of 8)
- Fold Down Mount (see sheet 6 of 8)
- Removable Shallow Mount (see sheet 7 of 8)
- Optional Chain Accessory (see sheet 8 of 8)

**RELIANCE FOUNDRY**  
SINCE 1925

Unit 207, 6450 - 148 Street, Surrey, BC V3S 7G7, Canada  
1-888-735-5680 info@reliance-foundry.com  
[www.reliance-foundry.com](http://www.reliance-foundry.com)

TITLE			
Bollard Post, Model R-7902			
SIZE	DWG NO	REV	
C	R-7902	C2	
NOT TO SCALE		SHEET 4 OF 8	

# Bollard Post, Model R-7902

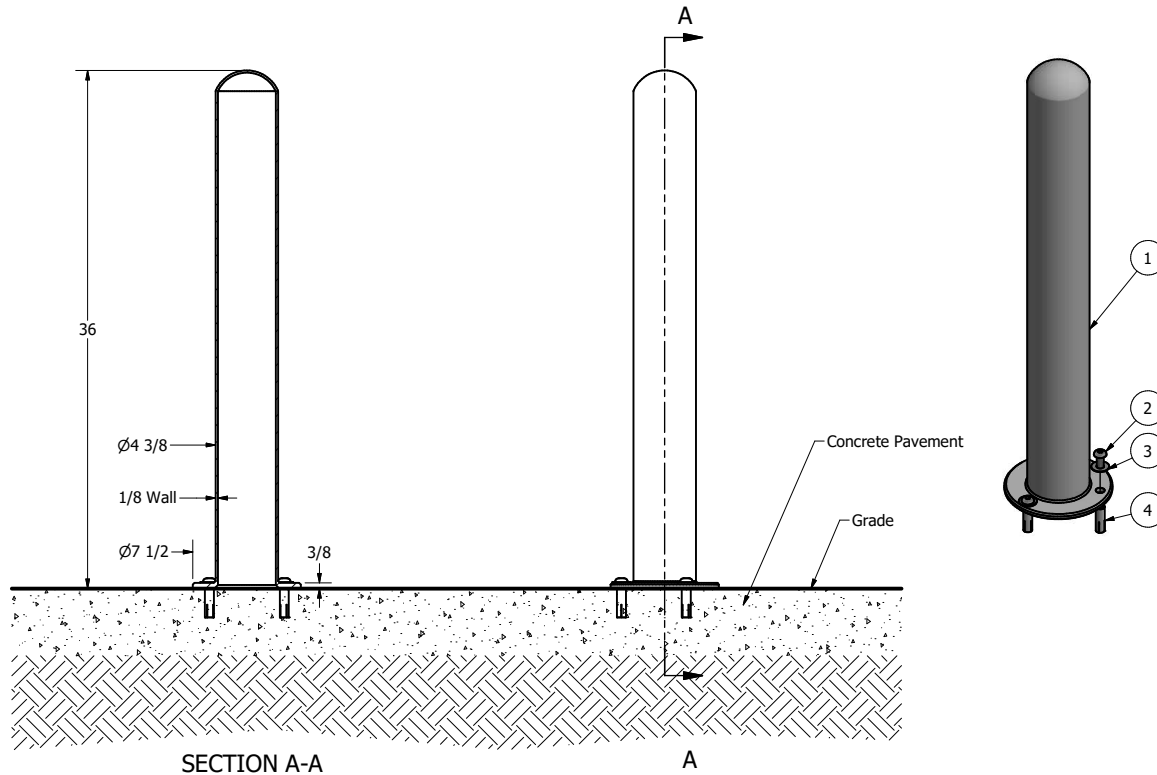
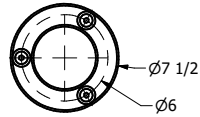

SECTION A-A

A

## Flanged / Surface Mount

### Notes:

- Embedment details are for reference illustration only. Minimum foundation sizes depend on local soil conditions, weather conditions, and engineering requirements.
- Bollard post is provided as shown, with material detailed in legend below. Concrete, foundation and/or installation ordered separately or provided by others.
- This drawing is not drawn to scale. Dimensions provided herein is for reference only. Please consult Reliance Foundry sales professionals if any dimension is critical to your particular installation.
- Reliance Foundry reserves the right to amend design and specifications without prior notice for product improvement.

### General Description:

Make a pronounced statement on entry to your streetscape, business, park, school or stadium with the contemporary and practical design of the model R-7902 steel bollard. A staple of the product line, it will complement the aesthetics of almost any architectural style. It can be embedded in new concrete or surface-mounted on existing concrete. For locations where access needs fluctuate, it can also be installed with removable or fold down mountings. The model R-7902 can be finished in one of seven different powder-coated color options and it is kept in stock, available to ship immediately.

For more information on bollard post installation, please visit: [www.reliance-foundry.com/bollard/installation-bollards](http://www.reliance-foundry.com/bollard/installation-bollards)

### Specifications:

Height: 36" ( Above Grade )

Base Diameter: 4 3/8"

Weight: 31 lbs ( Bollard Post Full Length )

Material: Steel ( ASTM A36 )

#### Finish Options:

- ✓ Polyester Powdercoated
- See Reliance Foundry's standard color options at [www.reliance-foundry.com/bollard/colors-bollards](http://www.reliance-foundry.com/bollard/colors-bollards)

### Mount Options:

- Removable Receiver with Lid (see sheet 2 of 8)
- Removable Receiver with Chain (see sheet 3 of 8)
- Fixed Embedded Mount (see sheet 4 of 8)
- ✓  Flanged Surface Mount (see sheet 5 of 8)
- Fold Down Mount (see sheet 6 of 8)
- Removable Shallow Mount (see sheet 7 of 8)
- Optional Chain Accessory (see sheet 8 of 8)

**RELIANCE FOUNDRY**  
SINCE 1925

Unit 207, 6450 - 148 Street, Surrey, BC V3S 7G7, Canada  
1-888-735-5680 info@reliance-foundry.com  
[www.reliance-foundry.com](http://www.reliance-foundry.com)

TITLE

**Bollard Post, Model R-7902**

SIZE  
C

DWG NO  
R-7902

REV  
C2

PARTS LIST					
ITEM	QTY	PART NUMBER	DESCRIPTION	MATERIAL	WEIGHT
1	1	R7902 Flanged Bollard	R7902 Flanged Bollard Body	Steel Powder Coated	30 lbs
2	3	Button Head Bolt 1/2" x 1 1/4"	Hexagon Socket Button Head Cap Bolt 1/2" x 1 1/4" - requires 5/16" hex key	Stainless Steel	1/8 lbs
3	3	Stainless Steel Washer 1/2"	Stainless Steel Washer 1/2" OD 1 1/4" Thick .05"	Stainless Steel	
4	3	Drop-in Concrete Insert 1/2"	Drop-in Concrete Insert 1/2" - requires 5/8" x 2" hole (dia. x depth)	Steel Plated	1/8 lbs

# Bollard Post, Model R-7902

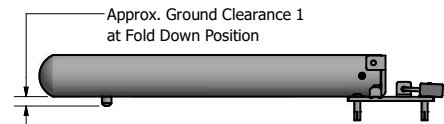
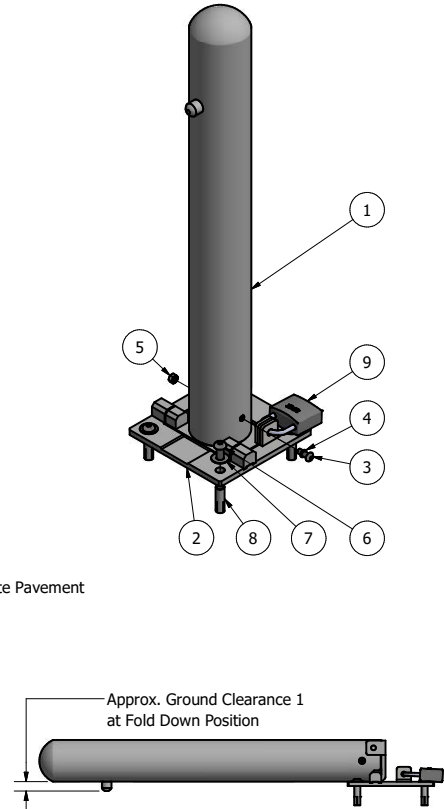
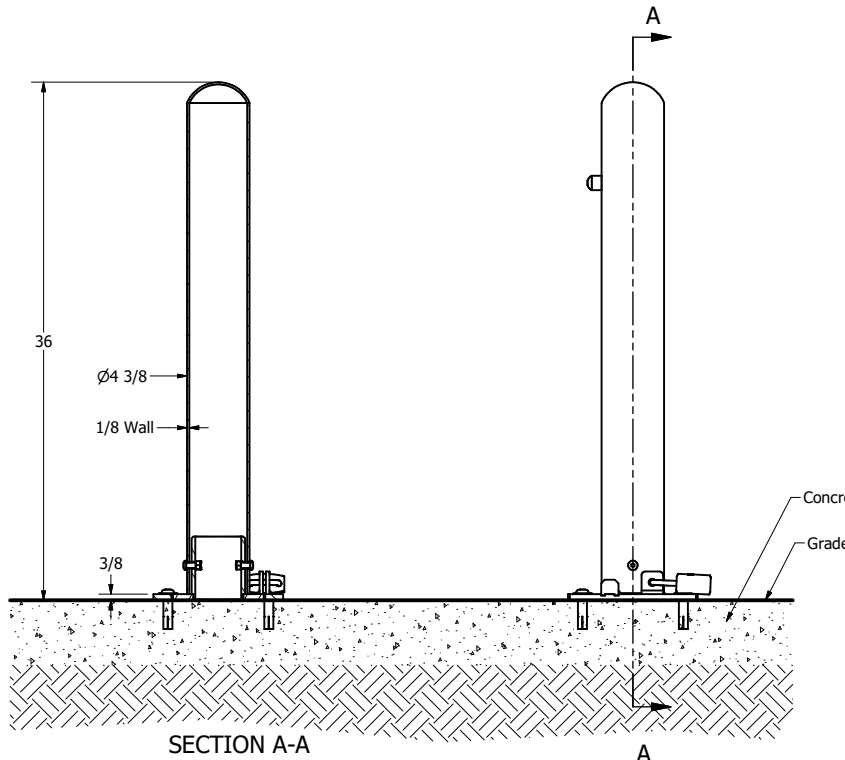
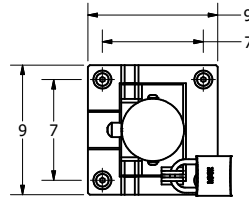

## Fold Down Mount

### Notes:

- Embedment details are for reference illustration only. Minimum foundation sizes depend on local soil conditions, weather conditions, and engineering requirements.
- Bollard post is provided as shown, with material detailed in legend below. Concrete, foundation and/or installation ordered separately or provided by others.
- This drawing is not drawn to scale. Dimensions provided herein is for reference only. Please consult Reliance Foundry sales professionals if any dimension is critical to your particular installation.
- Reliance Foundry reserves the right to amend design and specifications without prior notice for product improvement.

PARTS LIST						
ITEM	QTY	PART NUMBER	DESCRIPTION	MATERIAL	WEIGHT	
1	1	R7902 Fold Down Bollard	R7902 Fold Down Bollard Assembly	Steel Powder Coated	27 lbs	
2	1	R7950A Fold Down Base	R7950A Fold Down Base Assembly	Steel HDG	15 lbs	
3	2	Button Head Bolt 3/8" x 1"	Hexagon Socket Button Head Cap Bolt 3/8" x 1" - requires 7/32" hex key	Stainless Steel		
4	2	O-Ring 3/8"	Nitrile Rubber O-Ring 3/8"	Nitrile Rubber		
5	2	Hex Nut Nylon Lock 3/8"	Hex Nut Nylon Lock 3/8" - requires 9/16" wrench	Steel Plated Nylon Lock		
6	4	Button Head Bolt 1/2" x 1 1/4"	Hexagon Socket Button Head Cap Bolt 1/2" x 1 1/4" - requires 5/16" hex key	Stainless Steel	1/8 lbs	
7	4	Stainless Steel Washer 1/2"	Stainless Steel Washer 1/2" OD 1 1/4" Thick .05"	Stainless Steel		
8	4	Drop-in Concrete Insert 1/2"	Drop-in Concrete Insert 1/2" - requires 5/8" x 2" hole (dia. x depth)	Steel Plated	1/8 lbs	
9	1	Padlock (Optional)	Optional Padlock (Brass or Stainless Steel)	Choice of Brass or Stainless Steel	5/8 lbs	

### General Description:

Make a pronounced statement on entry to your streetscape, business, park, school or stadium with the contemporary and practical design of the model R-7902 steel bollard. A staple of the product line, it will complement the aesthetics of almost any architectural style. It can be embedded in new concrete or surface-mounted on existing concrete. For locations where access needs fluctuate, it can also be installed with removable or fold down mountings. The model R-7902 can be finished in one of seven different powder-coated color options and it is kept in stock, available to ship immediately.

For more information on bollard post installation, please visit: [www.reliance-foundry.com/bollard/installation-bollards](http://www.reliance-foundry.com/bollard/installation-bollards)

### Specifications:

- Height: 36" ( Above Grade )
- Base Diameter: 4 3/8"
- Weight: 31 lbs ( Bollard Post Full Length )
- Material: Steel ( ASTM A36 )

### Finish Options:

- ✓ Polyester Powdercoated
- See Reliance Foundry's standard color options at [www.reliance-foundry.com/bollard/colors-bollards](http://www.reliance-foundry.com/bollard/colors-bollards)

### Mount Options:

- Removable Receiver with Lid (see sheet 2 of 8)
- Removable Receiver with Chain (see sheet 3 of 8)
- Fixed Embedded Mount (see sheet 4 of 8)
- Flanged Surface Mount (see sheet 5 of 8)
- ✓  Fold Down Mount (see sheet 6 of 8)
- Removable Shallow Mount (see sheet 7 of 8)
- Optional Chain Accessory (see sheet 8 of 8)



Unit 207, 6450 - 148 Street, Surrey, BC V3S 7G7, Canada  
1-888-735-5680 info@reliance-foundry.com  
[www.reliance-foundry.com](http://www.reliance-foundry.com)

## Bollard Post, Model R-7902

SIZE	DWG NO	REV
C	R-7902	C2

# Bollard Post, Model R-7902

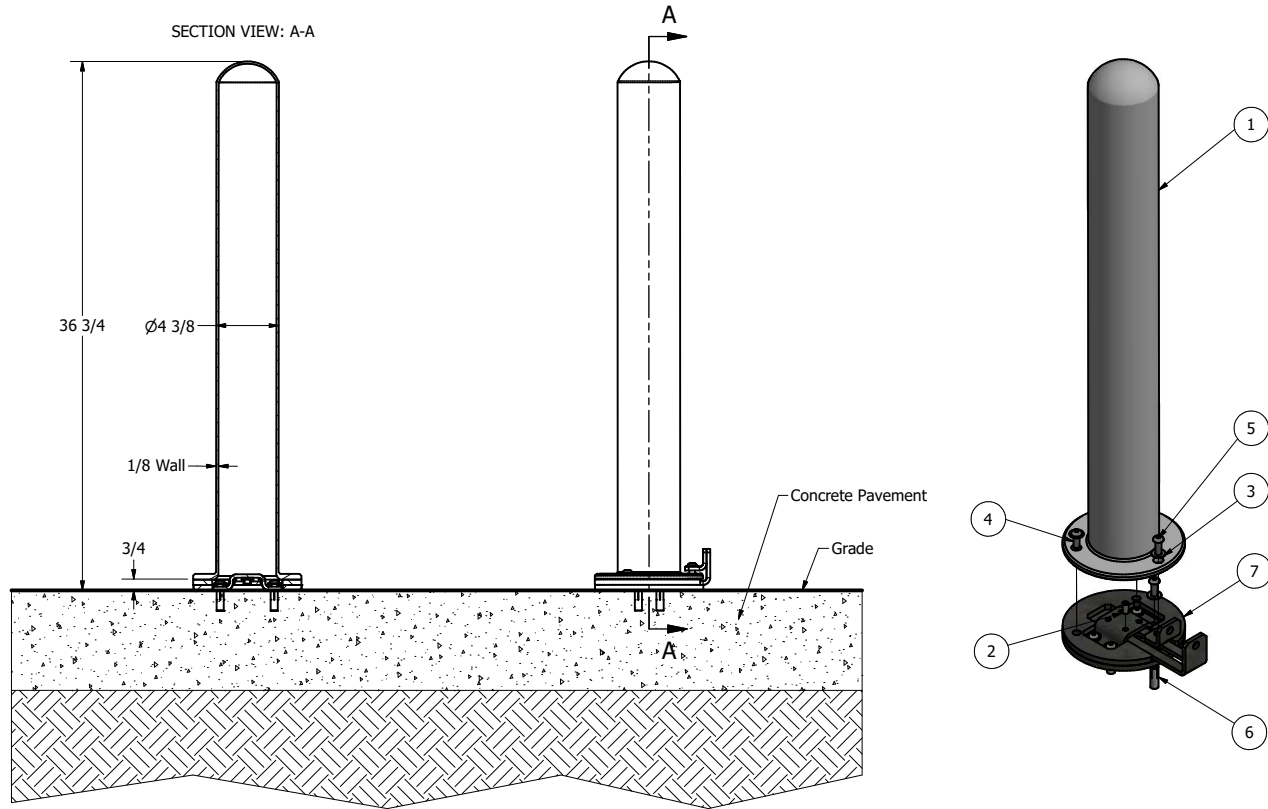

## Notes:

- Embedment details are for reference illustration only. Minimum foundation sizes depend on local soil conditions, weather conditions, and engineering requirements.
- Bollard post is provided as shown, with material detailed in legend below. Concrete, foundation and/or installation ordered separately or provided by others.
- This drawing is not drawn to scale. Dimensions provided herein is for reference only. Please consult Reliance Foundry sales professionals if any dimension is critical to your particular installation.
- Reliance Foundry reserves the right to amend design and specifications without prior notice for product improvement.

## General Description:

Make a pronounced statement on entry to your streetscape, business, park, school or stadium with the contemporary and practical design of the model R-7902 steel bollard. A staple of the product line, it will complement the aesthetics of almost any architectural style. It can be embedded in new concrete or surface-mounted on existing concrete. For locations where access needs fluctuate, it can also be installed with removable or fold down mountings. The model R-7902 can be finished in one of seven different powder-coated color options and it is kept in stock, available to ship immediately.

For more information on bollard post installation, please visit: [www.reliance-foundry.com/bollard/installation-bollards](http://www.reliance-foundry.com/bollard/installation-bollards)

## Specifications:

Height: 36" ( Above Grade )

Base Diameter: 4 3/8"

Weight: 31 lbs ( Bollard Post Full Length )

Material: Steel ( ASTM A36 )

### Finish Options:

- ✓ Polyester Powdercoated
- See Reliance Foundry's standard color options at [www.reliance-foundry.com/bollard/colors-bollards](http://www.reliance-foundry.com/bollard/colors-bollards)

## Mount Options:

- Removable Receiver with Lid (see sheet 2 of 8)
- Removable Receiver with Chain (see sheet 3 of 8)
- Fixed Embedded Mount (see sheet 4 of 8)
- Flanged Surface Mount (see sheet 5 of 8)
- Fold Down Mount (see sheet 6 of 8)
- ✓ Removable Shallow Mount (see sheet 7 of 8)
- Optional Chain Accessory (see sheet 8 of 8)

PARTS LIST						
ITEM	QTY	PART NUMBER	DESCRIPTION	MATERIAL	WEIGHT	
1	1	R7902 Flanged Bollard	R7902 Flanged Bollard Body	Steel Powder Coated	30 lbs	
2	4	Hexagon Socket Set Screw 3/8" x 3/4"	Hexagon Socket Set Screw 3/8" x 3/4" - requires 3/16" hex key	Stainless Steel		
3	7	Stainless Steel Washer 3/8"	Stainless Steel Washer 3/8" OD 7/8" Thick .05"	Stainless Steel		
4	2	Button Head Bolt 3/8" x 1"	Hexagon Socket Button Head Cap Bolt 3/8" x 1" - requires 7/32" hex key	Stainless Steel		
5	5	Button Head Bolt 3/8" x 1 1/4"	Hexagon Socket Button Head Cap Bolt 3/8" x 1 1/4" - requires 7/32" hex key	Stainless Steel		
6	4	Drop-in Concrete Insert 3/8"	Drop-in Concrete Insert 3/8" - requires 1/2" x 1 1/2" hole (dia. x depth)	Steel Plated		
7	1	R7960R	Shallow Removable Mount	Steel Plated	8 lbs	

**RELIANCE FOUNDRY**  
SINCE 1925

Unit 207, 6450 - 148 Street, Surrey, BC V3S 7G7, Canada  
1-888-735-5680 info@reliance-foundry.com  
[www.reliance-foundry.com](http://www.reliance-foundry.com)

**Bollard Post, Model R-7902**

SIZE C	DWG NO R7902F_R7960R	REV C2
-----------	-------------------------	-----------

# Bollard Post, Model R-7902

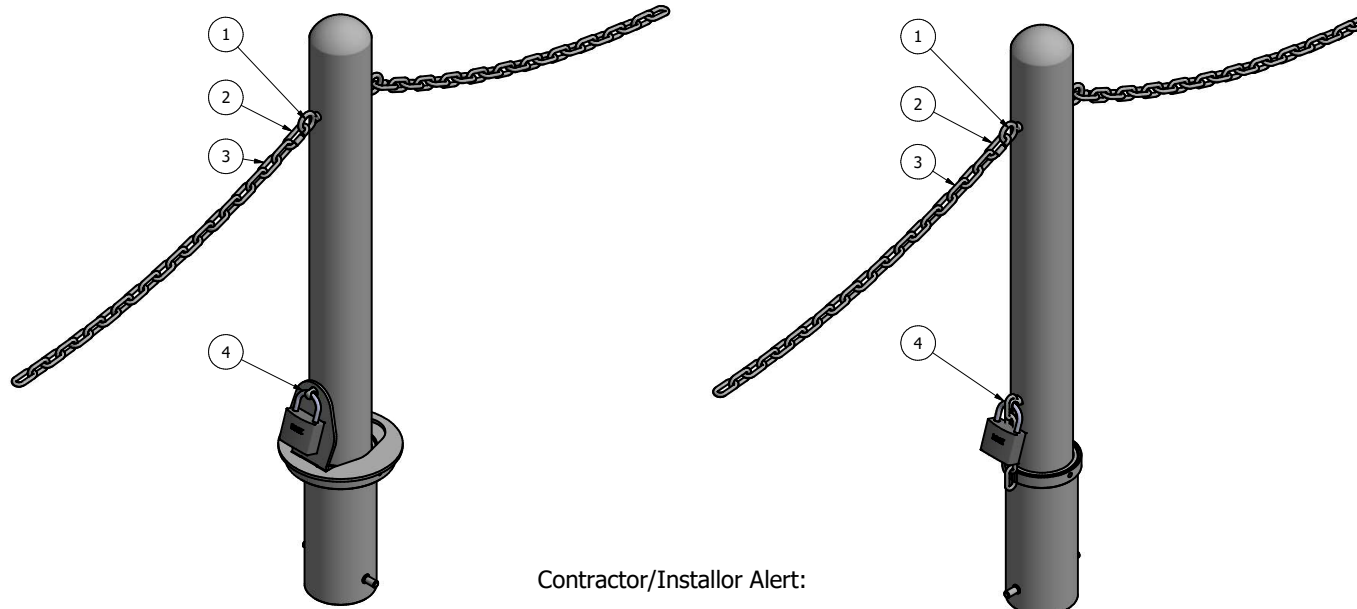

### Contractor/Installor Alert:

Please give consideration to the location of the chain eye and the padlock pin when installing removable bollard receiver. It is important that the removable bollard receiver padlock pin is oriented in the same direction as the chain is intended to flow.

### General Description:

Make a pronounced statement on entry to your streetscape, business, park, school or stadium with the contemporary and practical design of the model R-7902 steel bollard. A staple of the product line, it will complement the aesthetics of almost any architectural style. It can be embedded in new concrete or surface-mounted on existing concrete. For locations where access needs fluctuate, it can also be installed with removable or fold down mountings. The model R-7902 can be finished in one of seven different powder-coated color options and it is kept in stock, available to ship immediately.

For more information on bollard post installation, please visit: [www.reliance-foundry.com/bollard/installation-bollards](http://www.reliance-foundry.com/bollard/installation-bollards)

### Specifications:

Height: 36" ( Above Grade )

Base Diameter: 4 3/8"

Weight: 31 lbs ( Bollard Post Full Length )

Material: Steel ( ASTM A36 )

#### Finish Options:

- ✓ Polyester Powdercoated
- See Reliance Foundry's standard color options at [www.reliance-foundry.com/bollard/colors-bollards](http://www.reliance-foundry.com/bollard/colors-bollards)

### Mount Options:

- Removable Receiver with Lid (see sheet 2 of 8)
- Removable Receiver with Chain (see sheet 3 of 8)
- Fixed Embedded Mount (see sheet 4 of 8)
- Flanged Surface Mount (see sheet 5 of 8)
- Fold Down Mount (see sheet 6 of 8)
- Removable Shallow Mount (see sheet 7 of 8)
- ✓  Optional Chain Accessory (see sheet 8 of 8)

## Optional Chain Accessories Installation Details

PARTS LIST			
ITEM	PART NUMBER	DESCRIPTION	MATERIAL
1	Chain Eye 3/8" (Optional)	Optional Chain Eye 3/8"	Steel Powder Coated
2	Quick Link Connector (Optional)	Optional Quick Link Connector	Steel Powder Coated
3	Chain 5/16" (Optional)	Optional Chain 5/16" (Sold by Length)	Steel Powder Coated
4	Padlock (Optional)	Optional Padlock (Brass or Stainless Steel)	Choice of Brass or Stainless Steel

**RELIANCE FOUNDRY**  
SINCE 1925

Unit 207, 6450 - 148 Street, Surrey, BC V3S 7G7, Canada  
1-888-735-5680 info@reliance-foundry.com  
[www.reliance-foundry.com](http://www.reliance-foundry.com)

**Bollard Post, Model R-7902**

SIZE C DWG NO R-7902 REV C2